



Installation Manual INE-W928R Kit

colour: black

- Seat Alhambra (6N)
- Škoda Fabia II
- Škoda Octavia II
- Škoda Roomster
- VW Caddy
- VW Sharan
- VW Tiguan
- VW Touran

part-no.:
KIT-8VWT
KIT-8VWTD

Compatible with these Alpine navigation devices

INE-W928R

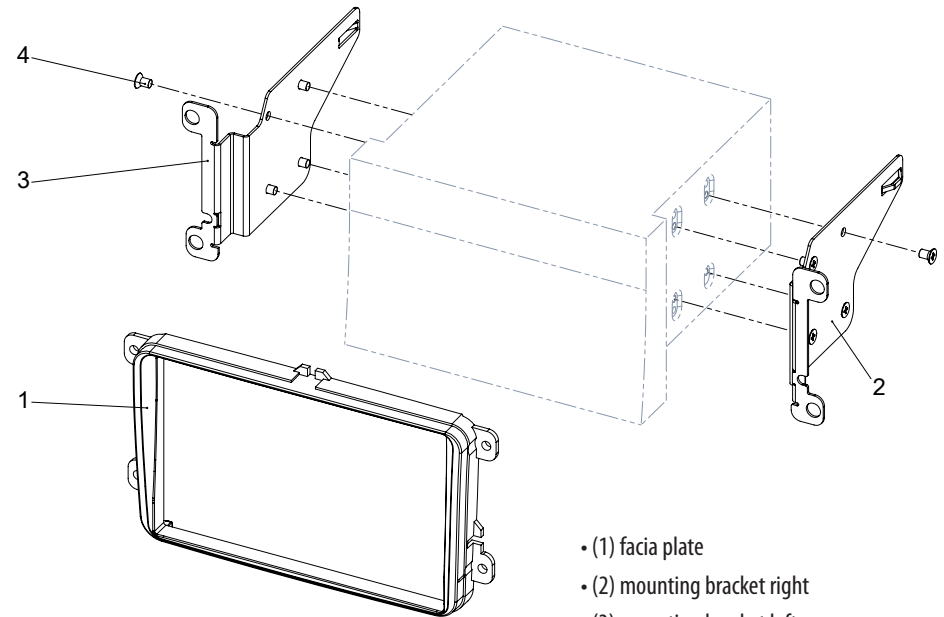

- (1) facia plate
- (2) mounting bracket right
- (3) mounting bracket left
- (4) recessed countersunk flat head screw

*All installation work must be performed by a qualified professional installer only.
The manufacturer / dealer is not liable for any kind of incidental or indirect damages.*

Škoda Fabia II / Octavia II / Roomster / VW Caddy / Touran



1. Unclip and remove OEM panel
(see arrows)



2. Remove 4 screws

Remove head unit

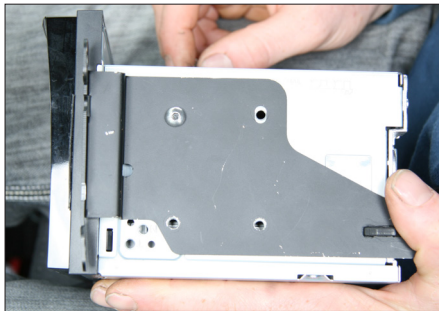

3. Attach mounting frames to
Alpine INE-W928R



4. Connect all required circuit points

Place Alpine INE-W928R
on dashboard

VW Tiguan

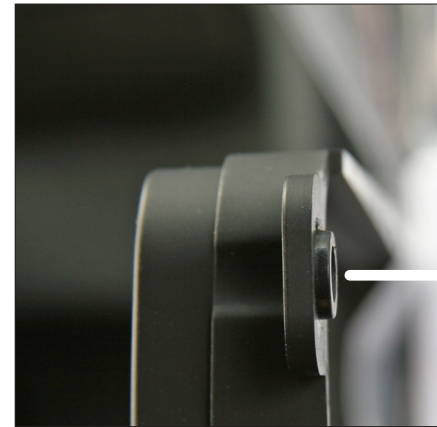

5. Connect all required
circuit points
Place Alpine INE-W928R
on dashboard

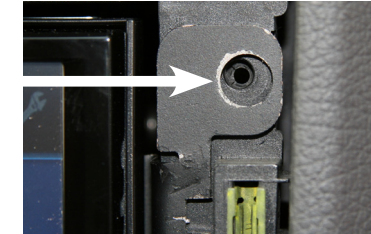

Place fascia plate
*Put dome of fascia plate
exactly over the holes of
mounting frames
(see arrow above)*



Install OEM panel to finish
installation

VW Tiguan



1. Unclip and remove OEM panel (see arrows)

Remove 4 screws of OEM head unit



2. Remove 4 screws

Remove head unit

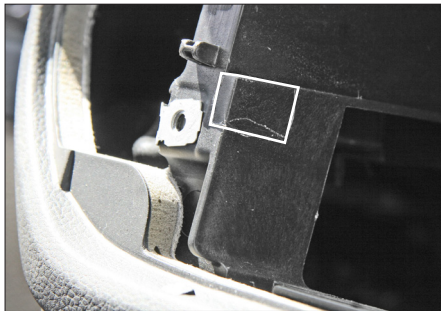

3. Cut away plastic to clear space for Alpine INE-W928R

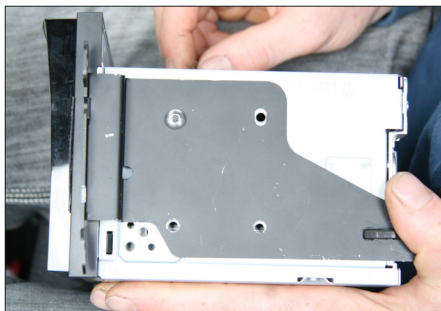

4. Attach mounting frames to Alpine INE-W928R

Škoda Fabia II / Octavia II / Roomster / VW Caddy / Touran

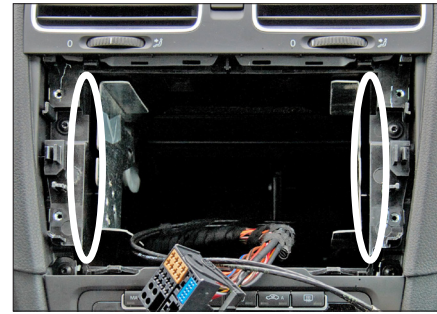

5. If necessary:
Cut away plastic to clear space for Alpine INE-W928R

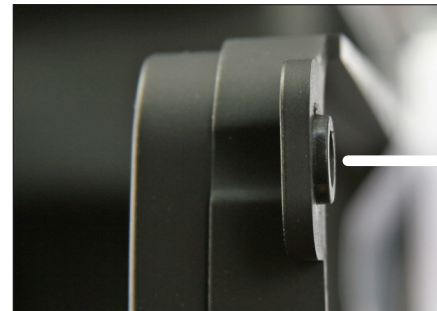

6. Place fascia plate

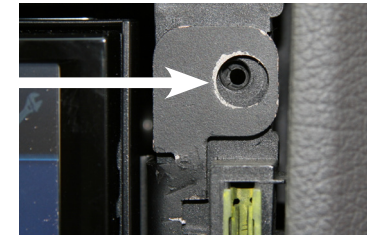

Put dome of fascia plate exactly over the holes of mounting frames (see arrow above)

Fix fascia plate with 4 screws



7. Install OEM panel to finish installation



Seat Alhambra / VW Sharan



1. Open top shelf
Remove 2 screws



2. Remove top shelf inlay
Remove 2 screws on top



3. Remove OEM panel

Seat Alhambra / VW Sharan



4. Remove 4 screws
Remove OEM head unit

If necessary:
Cut away plastic to clear space
for Alpine INE-W928R

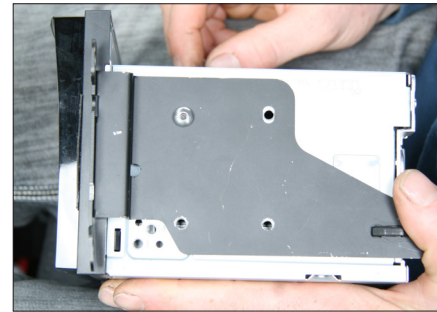

5. Attach mounting frames to
Alpine INE-W928R

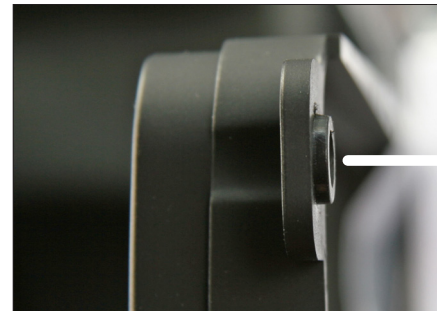

6. Place fascia plate

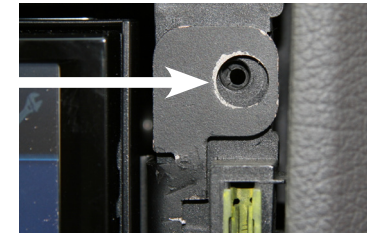

7. Connect all required circuit
points
Place Alpine INE-W928R
on dashboard

Fix fascia plate with 4 screws
Install everything in reverse
order to finish installation